

WV 2

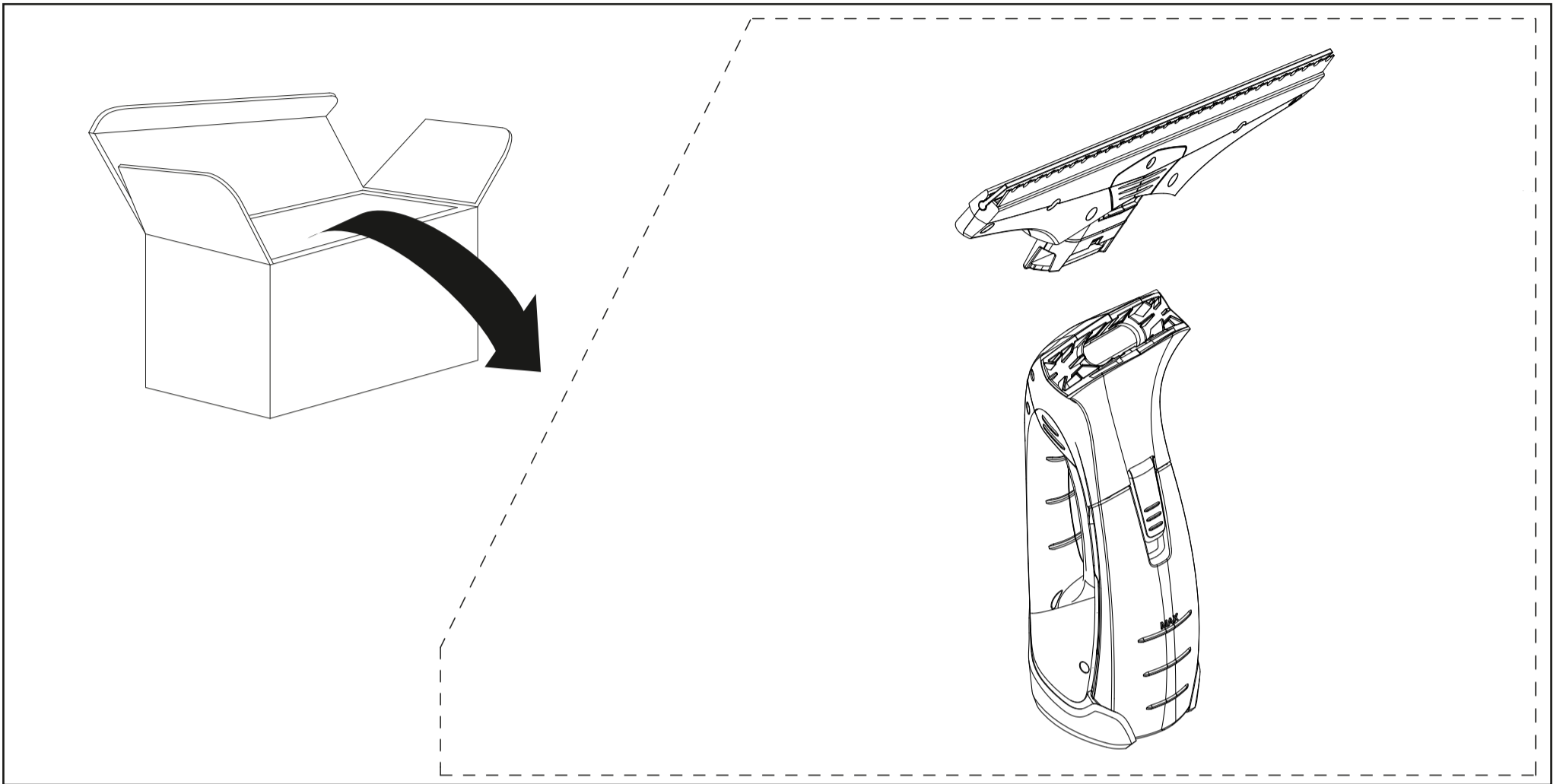

<p>Li-Ion</p>	3,7 V		IPX4		0,6 kg				
<p>nom</p>	10 W		100 ml		185 min				
	<table border="1"> <tr> <td>V</td> <td>5,5</td> </tr> <tr> <td>mA</td> <td>600</td> </tr> </table>	V	5,5	mA	600		50 db(A)		35 min
V	5,5								
mA	600								

